

# data sheet: L2G40

Kroepelin GmbH  
Gartenstraße 50  
D-36381 Schlüchtern

Tel.: 06661 86 0  
Fax: 06661 86 39  
Mail: sales@kroepelin.com  
Web: www.kroepelin.com

**Kroepelin**  
Längenmesstechnik

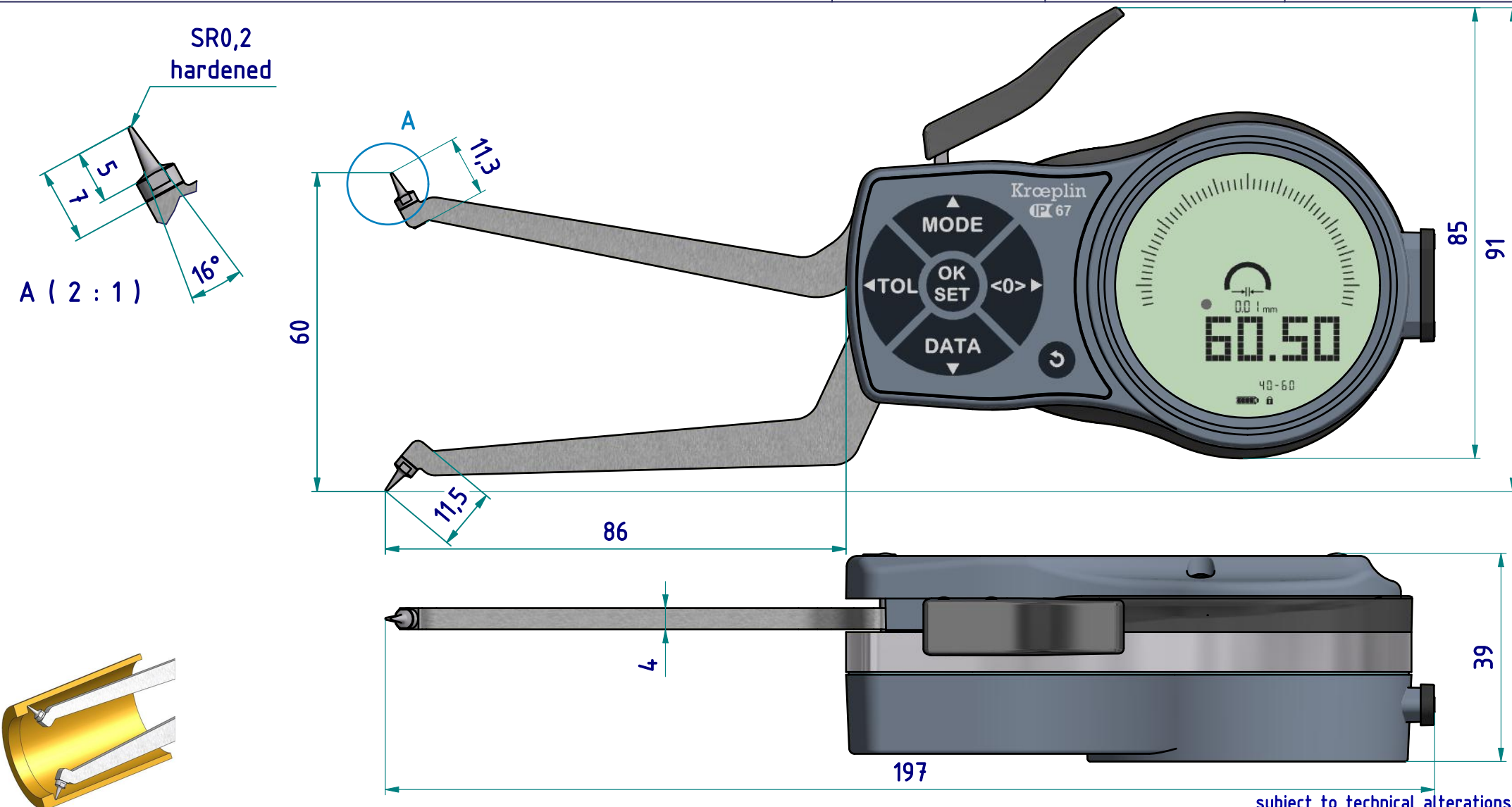

subject to technical alterations

type: L  
range: 40 - 60 mm  
range of indication: 39,5 - 60,5 mm  
digital step: 0,01 mm  
scale interval: -  
measuring force: 1,1 - 1,6 N  
weight: 285 g

acceptable deviations  
VDI/VDE/DGQ 2618 Bl. 12.1/13.1)  
max. permissible  
errors "G": 0,03 mm  
repeatability "r": 0,01 mm  
reference temperature: 20° C  
operation temperature: 10° C - 30° C  
storage temperature: -10° C - 50° C

scale: 1:1  
drawing-nr.: DAB-L2G40-K-e  
date of issue: 13.05.2020  
name: B. Schmidt  
revision status: 001  
revision date: 23.09.2020

interface as accessories available:

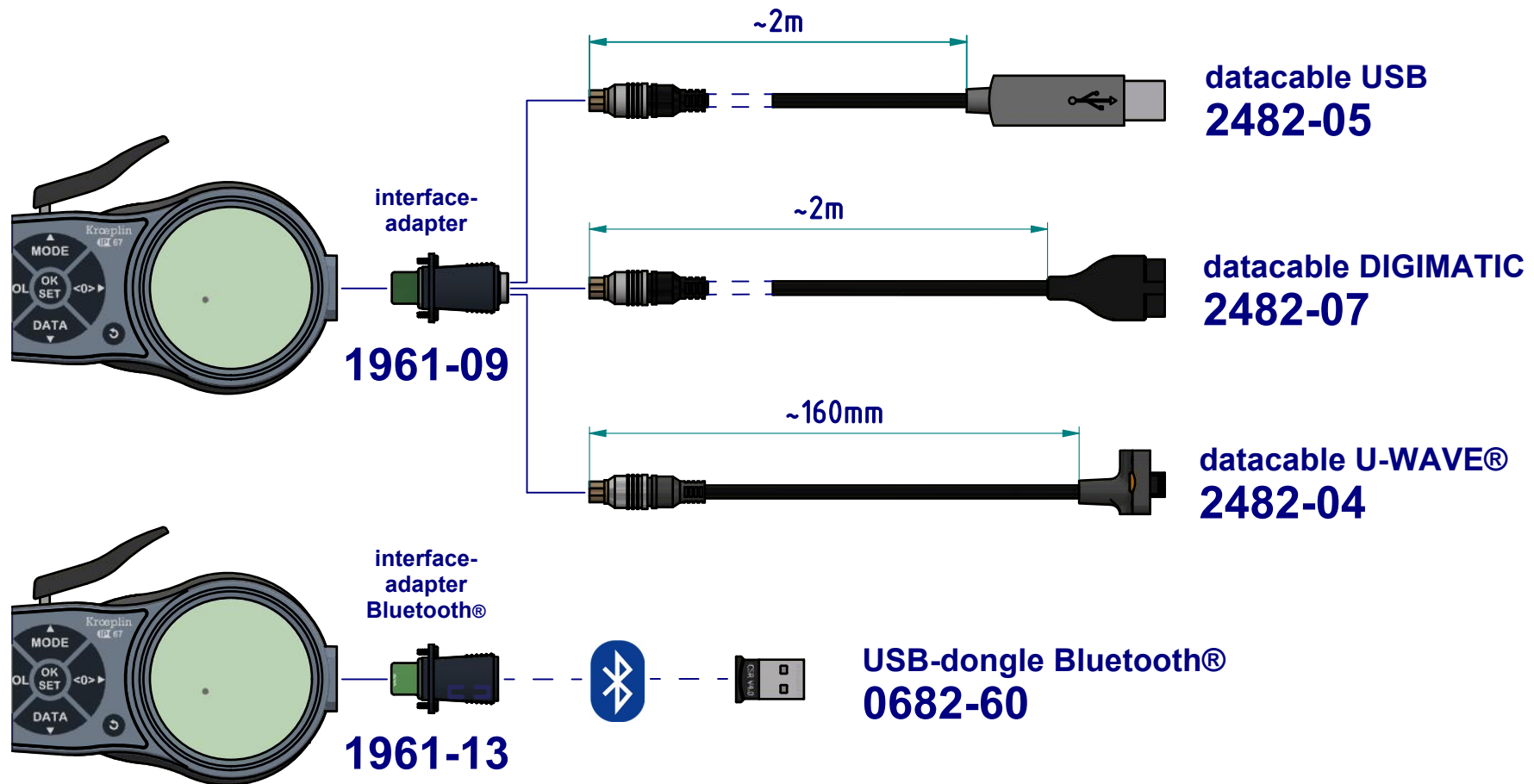

subject to technical alterations

drawing-nr.:	DAB-L2G40-K-e
date of issue:	13.05.2020
name:	B. Schmidt
revision status:	001
revision date:	23.09.2020