

# IRIS E

Electronic measuring gauge for external measurement  
Strumento digitale per misurazioni esterne



DIGITAL DIAL GAUGES COMPARATORI DIGITALI A BRACCI



WATER RESISTANT



OPTO/RS232



WOODEN CASE



OPTO/USB

**PRESET**  
mm-inch.

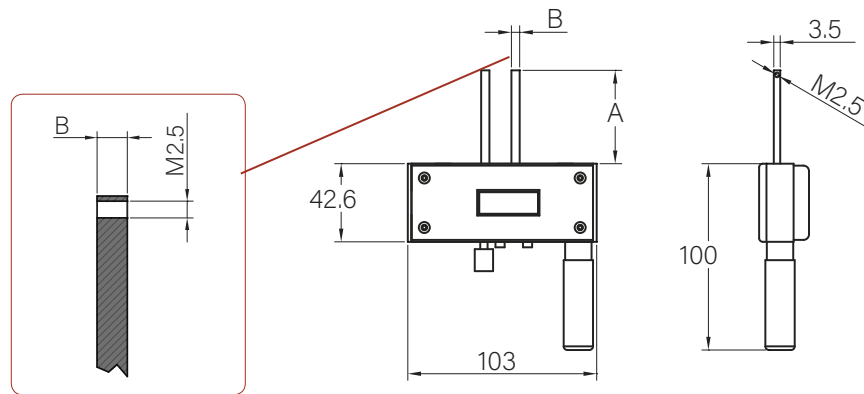

Article	Range	A	B	Resolution	Accuracy	Code	Kg
IRIS 50 E-U 0/24	0-24	50	4,5	0,01	0,01	00372	0,300
IRIS 50 E-U 17/41	17-41	50	4,5	0,01	0,01	00373	0,300
IRIS 80 E-U 0/24	0-24	80	6	0,01	0,01	00269	0,300
IRIS 80 E-U 14/38	14-38	80	6	0,01	0,01	00275	0,300

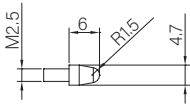

Article	Code
U	00489

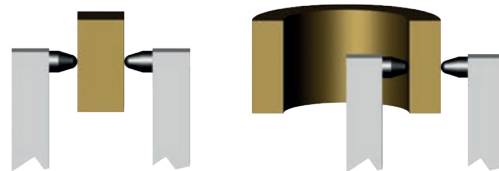

Article	Range	A	B	Resolution	Accuracy	Code	Kg
IRIS 50 E-W 0/16	0-16	50	4,5	0,01	0,01	00392	0,300
IRIS 50 E-W 9/33	9-33	50	4,5	0,01	0,01	00393	0,300
IRIS 80 E-W 0/16	0-16	80	6	0,01	0,01	00394	0,300
IRIS 80 E-W 9/33	9-33	80	6	0,01	0,01	00395	0,300

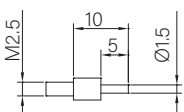

Article	Code
W	00490

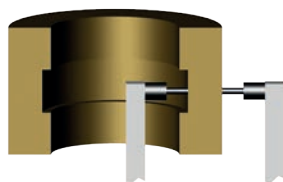

GAUGES  
CALIBRI

ALESAMETRI  
ALLESAMETRI

BIG CALIPERS  
GRANDI CALIBRI

HEIGHT GAGE  
TRUSCHINI

PRECISION  
STRAIGHT EDGE  
RIGHE DI CONTROLLO

MEASURE INSTRUMENTS  
STRUMENTI  
DI CONTROLLO

PRESETTING  
PRESETTING

GEARS INSTRUMENTS  
STRUMENTI PER  
INGRANAGGI

DIAL GAUGES  
COMPARATORI

ACCESSORIES  
ACCESSORI

Article	Range	A	B	Resolution	Accuracy	Code	Kg
IRIS 50 E-TS 0/12	0-12	50	4,5	0,01	0,01	00277	0,300
IRIS 50 E-TS 5/29	5-29	50	4,5	0,01	0,01	00278	0,300
IRIS 80 E-TS 0/12	0-12	80	6	0,01	0,01	00295	0,300
IRIS 80 E-TS 5/29	5-29	80	6	0,01	0,01	00297	0,300

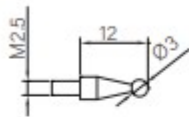

Article	Code
TS3	02030



RODS WITH SPHERE TSA Ø3 STANDARD EQUIPMENT  
TERMINALI A SFERA TSA Ø3 IN DOTAZIONE STANDARD



### INTERCHANGEABLE RODS OPTIONAL OPZIONE TERMINALI INTERCAMBIABILI PER MODELLO E-TS

INTERCHANGEABLE RODS WITH SPHERE  
TERMINALI INTERCAMBIABILI CON SFERE CALIBRATE

Article	Ø	Code	Kg
TS 1	Ø 1	02010	0,005
TS 1,5	Ø 1,5	02015	0,005
TS 2	Ø 2	02020	0,005
TS 2,5	Ø 2,5	02025	0,005
TS 3	Ø 3	02030	0,005
TS 3,5	Ø 3,5	02035	0,005
TS 4	Ø 4	02040	0,005
TS 4,5	Ø 4,5	02045	0,005
TS 5	Ø 5	02050	0,005
TS 5,5	Ø 5,5	02055	0,005
TS 6	Ø 6	02060	0,005
TS 6,5	Ø 6,5	02065	0,005

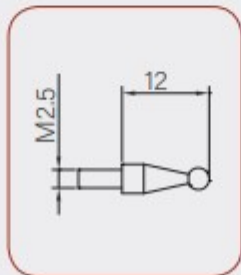

INTERCHANGEABLE RODS OF WIDIA  
TERMINALI INTERCAMBIABILI CON SFERE IN WIDIA

Article	Ø	Code	Kg
TSW 1	Ø 1	02011	0,005
TSW 1,5	Ø 1,5	02016	0,008
TSW 2	Ø 2	02021	0,008
TSW 2,5	Ø 2,5	02026	0,008
TSW 3	Ø 3	02031	0,008
TSW 3,5	Ø 3,5	02036	0,008
TSW 4	Ø 4	02041	0,008
TSW 4,5	Ø 4,5	02046	0,008
TSW 5	Ø 5	02051	0,008
TSW 5,5	Ø 5,5	02056	0,008
TSW 6	Ø 6	02061	0,008
TSW 6,5	Ø 6,5	02066	0,008