

**Werkstattmessschieber ohne  
Messerspitzen ohne Feineinstellung**



- DIN 862
- Feststellschraube
- Lochmaßansatz:
- 0 - 300 mm = 10 mm
- 500 - 1000 mm = 20 mm
- rostfreier Stahl
- Nonius + Skala mattverchromt
- inkl. Kunststoffetui



110-22

*Vernier caliper without knife-edge without  
fine adjustment*

- DIN 862
- lock screw
- nibs for inside measuring:
- 0 - 300 mm = 10 mm
- 500 - 1000 mm = 20 mm
- stainless steel
- scale and vernier satin chromed
- incl. box

> mm <	 mm	 inch	 mm	No.
300	0,05	1/128	90	110-22
500	0,05	1/128	150	110-34
800	0,05	1/128	150	110-36
1000	0,05	1/128	150	110-37*
1500	0,05	1/128	200	113-14*

\* ab Werk/EXW

**Werkstattmessschieber mit Messerspitzen ohne  
Feineinstellung**

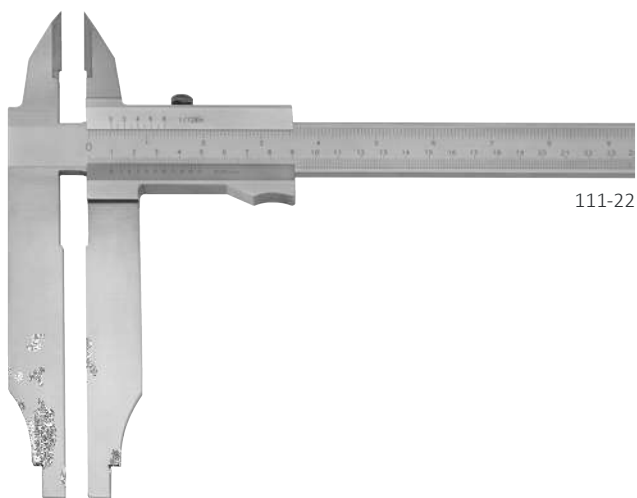

- DIN 862
- Feststellschraube
- Lochmaßansatz:
- 0 - 300 mm = 10 mm
- 500 - 1000 mm = 20 mm
- rostfreier Stahl
- Nonius + Skala mattverchromt
- inkl. Kunststoffetui





111-22

*Vernier caliper  
with knife-edge without fine adjustment*

- DIN 862
- lock screw
- nibs for inside measuring:
- 0 - 300 mm = 10 mm
- 500 - 1000 mm = 20 mm
- stainless steel
- scale and vernier satin chromed
- incl. box

> mm <	 mm	 inch	 mm	No.
250	0,05	1/128	90	111-21
300	0,05	1/128	90	111-22
500	0,05	1/128	150	111-34
800	0,05	1/128	150	111-36
1000	0,05	1/128	150	111-37*

> mm <    Messbereich    Range  
    Ablesung    Reading  
    Schnabellänge    Length of jaws

\* ab Werk/EXW